



EMC TEST REPORT

EN 55032: 2015

EN 55020:2007/A12:2016

EN 61000-3-2: 2014

EN 61000-3-3: 2013

MEASUREMENT AND TEST REPORT

For

Guangzhou Baolun Electronics Co., Ltd.

No.1, Building B Block, Zhongcun Street, Panyu District, Guangzhou, China

Model: T-770, T-770T, T-770A, T-770AT, VA-570, T-780, T-780S, T-220H, T-210, T-220BM, T-210BM, T-230BM, T-775RSW, T-776RSW, T-108L, T-740T, T-730, T-720AP, T-740B, T-740

January 25, 2019

This Report Concerns:	Equipment Type:
<input checked="" type="checkbox"/> Original Report	Projection Speaker
Test Engineer:	Eric/
Report Number:	TH19AR-149E
Test Date:	January 18~25, 2019
Reviewed By:	Prinzel/
Approved By:	Prinzel/
Prepared By:	Shenzhen Tian Hai Test Technology Co.,Ltd. 4F, A3 BLDG, The Silicon Valley Power Intelligent Terminal Industrial Park, Guan Lan Street, Longhua District, Shenzhen Tel: +86-755-86615100 Fax: +86-755-86615105

Note: This test report is limited to the above client company and the product model only. It may not be duplicated without prior written consent of Shenzhen Tian Hai Test Technology Co.,Ltd.



TABLE OF CONTENTS

1 - GENERAL INFORMATION..... 4

1.1 PRODUCT DESCRIPTION FOR EQUIPMENT UNDER TEST (EUT)..... 4

1.2 TEST STANDARDS..... 4

1.3 TEST SUMMARY..... 5

1.4 TEST METHODOLOGY..... 5

1.5 TEST EQUIPMENT LIST AND DETAILS..... 6

2 - SYSTEM TEST CONFIGURATION..... 7

2.1 JUSTIFICATION..... 7

2.2 EUT EXERCISE SOFTWARE..... 7

2.3 SPECIAL ACCESSORIES..... 7

2.4 BASIC CONFIGURATION OF TEST SYSTEM..... 7

2.5 TEST SETUP DIAGRAM..... 7

3 - DISTURBANCE VOLTAGE AT THE MAINS TERMINALS..... 8

3.1 MEASUREMENT UNCERTAINTY..... 8

3.2 LIMIT OF DISTURBANCE VOLTAGE AT THE MAINS TERMINALS (CLASS B)..... 8

3.3 EUT SETUP..... 8

3.4 INSTRUMENT SETUP..... 8

3.5 TEST PROCEDURE..... 9

3.6 SUMMARY OF TEST RESULTS..... 9

3.7 DISTURBANCE VOLTAGE TEST DATA..... 9

3.8 TEST RESULT..... 9

DISTURBANCE VOLTAGE TEST DATA..... 10

DISTURBANCE VOLTAGE TEST DATA..... 11

4 - DISTURBANCE POWER..... 12

4.1 LIMIT OF DISTURBANCE POWER..... 12

4.2 EUT SETUP..... 12

4.3 INSTRUMENTS SETUP..... 13

4.4 TEST PROCEDURE..... 13

4.5 DISTURBANCE POWER TEST DATA..... 13

4.6 TEST PLOT(S) FOR DISTURBANCE POWER..... 13

4.7 TEST RESULT..... 13

DISTURBANCE POWER TEST DATA..... 14

5 - HARMONIC CURRENT TEST (EN 61000-3-2)..... 15

5.1 APPLICATION OF HARMONIC CURRENT EMISSION..... 15

5.2 MEASUREMENT DATA..... 15

5.3 TEST RESULTS..... 15

6 - VOLTAGE FLUCTUATIONS AND FLICKER TEST (EN 61000-3-3)..... 16

6.1 APPLICATION OF VOLTAGE FLUCTUATIONS AND FLICKER TEST..... 16

6.2 MEASUREMENT DATA..... 16

6.3 TEST RESULTS..... 16

7 - EN 55020 TEST PROCEDURES..... 17

7.1 ELECTROSTATIC DISCHARGE TEST SYSTEM..... 17

7.2 RADIATED SUSCEPTIBILITY TEST SYSTEM..... 17

7.3 ELECTRICAL FAST TRANSIENT/BURST IMMUNITY TEST SYSTEM..... 17

7.4 SURGE IMMUNITY TEST SYSTEM..... 17

7.5 CONDUCTED SUSCEPTIBILITY TEST SYSTEM..... 17

7.6 POWER FREQUENCY MAGNETIC FIELD IMMUNITY TEST SYSTEM..... 17

7.7 VOLTAGE DIPS, SHORT INTERRUPTIONS IMMUNITY TESTS SYSTEM..... 17

7.8 EQUIPMENT TEST TABLE..... 18

7.9 INSTRUMENT CALIBRATION..... 18



8 - EN 55020 TEST PROCEDURES.....19

8.1 EUT AND CABLE PLACEMENT..... 19

8.2 APPLICATION OF ELECTROSTATIC DISCHARGE IMMUNITY TEST..... 19

8.3 APPLICATION OF RADIATED SUSCEPTIBILITY TEST..... 19

8.4 APPLICATION OF ELECTRICAL FAST TRANSIENT/BURST IMMUNITY TEST..... 19

8.5 APPLICATION OF SURGE IMMUNITY TEST..... 19

8.6 APPLICATION OF CONDUCTED SUSCEPTIBILITY TEST..... 19

8.7 APPLICATION OF POWER FREQUENCY MAGNETIC FIELD IMMUNITY TEST..... 20

8.8 APPLICATION OF VOLTAGE DIPS, SHORT INTERRUPTIONS IMMUNITY TESTS..... 20

8.9 DEVIATIONS FROM THE STANDARD..... 20

9 - TEST DATA.....21

9.1 ELECTROSTATIC DISCHARGE IMMUNITY TEST (IEC 61000-4-2)..... 21

9.2 RADIATED SUSCEPTIBILITY TEST (IEC 61000-4-3)..... 22

9.3 ELECTRICAL FAST TRANSIENT/BURST IMMUNITY TEST (IEC 61000-4-4)..... 22

9.4 SURGE IMMUNITY TEST (IEC 61000-4-5)..... 23

9.5 CONDUCTED SUSCEPTIBILITY TEST (IEC 61000-4-6)..... 23

9.6 VOLTAGE DIPS, SHORT INTERRUPTIONS IMMUNITY TESTS (IEC 61000-4-11)..... 24

10 - TEST RESULTS.....25

10.1 IEC 61000-4-2 ELECTROSTATIC DISCHARGE IMMUNITY TEST CONFIGURATION..... 25

10.2 IEC 61000-4-3 RADIATED SUSCEPTIBILITY TEST CONFIGURATION..... 25

10.3 IEC 61000-4-4 ELECTRICAL FAST TRANSIENT/BURST IMMUNITY TEST CONFIGURATION..... 25

10.4 IEC 61000-4-5 SURGE IMMUNITY TEST CONFIGURATION..... 25

10.5 IEC 61000-4-6 CONDUCTED SUSCEPTIBILITY TEST CONFIGURATION..... 25

10.6 IEC 61000-4-11 VOLTAGE DIPS, SHORT INTERRUPTIONS IMMUNITY TESTS CONFIGURATION..... 25

APPENDIX A - PRODUCT LABELING..... 26

CE MARKING LABEL SPECIFICATION..... 26

PROPOSED LABEL LOCATION ON EUT..... 26

APPENDIX B - EUT PHOTOGRAPHS..... 27

APPENDIX C - TEST SETUP PHOTOGRAPHS..... 29



1 - GENERAL INFORMATION

1.1 Product Description for Equipment Under Test (EUT)

Client Information

Applicant: **Guangzhou Baolun Electronics Co., Ltd.**
Address: No.1, Building B Block, Zhongcun Street, Panyu District, Guangzhou, China
Manufacturer: **Guangzhou Baolun Electronics Co., Ltd.**
Address: No.1, Building B Block, Zhongcun Street, Panyu District, Guangzhou, China

General Description of E.U.T

EUT Description: **Projection Speaker**
Trade mark: ITC
Model No.: T-770,T-770T,T-770A,T-770AT,VA-570,T-780,T-780S,T-220H,T-210,T-220BM,T-210BM,T-230BM,T-775RSW,T-776RSW,T-108L,T-740T,T-730,T-720AP,T-740B,T-740
Note: All the models are similar in appearance and dimensions.
Model T-770 was selected to do all the tests.

Remark: * The test data gathered are from the production sample provided by the manufacturer.

1.2 Test Standards

The following Declaration of Conformity report of EUT is prepared in accordance with

EN 55032: 2015

EN 55020:2007/A12:2016

EN 61000-3-2: 2014

EN 61000-3-3: 2013

The objective of the manufacturer is to demonstrate compliance with the described standards above.



1.3 Test Summary

For the EUT described above. The standards used were EN 55032 Class B for Emissions & EN 55020 for Immunity.

Table 1 : Tests Carried Out Under EN 55032: 2015

Standard	Test Items	Status
EN 55032: 2015	Disturbance Voltage at The Mains Terminals (0.15MHz To 30MHz)	√
	Disturbance Power (30MHz To 300MHz)	√

- √ Indicates that the test is applicable
- × Indicates that the test is not applicable

Table 2 : Tests Carried Out Under EN 61000-3-2: 2014/ EN 61000-3-3: 2013

Standard	Test Items	Status
EN 61000-3-2: 2014	Harmonic Current Test	√
EN 61000-3-3: 2013	Voltage Fluctuations and Flicker Test	√

- √ Indicates that the test is applicable
- × Indicates that the test is not applicable

Table 3 : Tests Carried Out Under EN 55032: 2015

Standard	Test Items	Status
EN61000-4-2:2009	Electrostatic discharge Immunity	√
EN 61000-4-3:2006+A1:2008 +A2:2010	Radiated Susceptibility (80MHz to 1GHz)	√
EN61000-4-4:2004+A1:2010	Electrical Fast Transient/Burst Immunity	√
EN61000-4-5:2006	Surge Immunity	√
EN61000-4-6:2009	Conducted Susceptibility (150kHz to 80MHz)	√
EN61000-4-8:2010	Power Frequency Magnetic Field Immunity (50/60Hz)	×
EN61000-4-11:2004	Voltage Dips, Short Interruptions Immunity	√

- √ Indicates that the test is applicable
- × Indicates that the test is not applicable

1.4 Test Methodology

All measurements contained in this report were conducted with CISPR 32, radio disturbance and immunity measuring apparatus, and CISPR 32, Method of measurement of disturbances and immunity



1.5 Test Equipment List and Details

No.	Equipment	Manufacturer	Model No.	S/N	Calculator date	Calculator due date
1	EMI Test Receiver	R&S	ESCI	100687	2018-03-16	2019-03-15
2	EMI Test Receiver	R&S	ESPI	100097	2018-03-16	2019-03-15
3	Amplifier	HP	8447D	1937A02492	2018-03-16	2019-03-15
4	Single Power Conductor Module	FCC	FCC-LISN-5-50-1-01-CISPR25	7101	2018-03-16	2019-03-15
5	Single Power Conductor Module	FCC	FCC-LISN-5-50-1-01-CISPR25	7102	2018-03-16	2019-03-15
6	Power Clamp	SCHWARZ BECK	MDS-21	3812	2018-03-16	2019-03-15
7	Positioning Controller	C&C	CC-C-1F	MF7802113	N/A	N/A
8	Electrostatic Discharge Simulator	TESEQ	NSG437	125	2018-03-16	2019-03-15
9	Fast Transient Burst Generator	SCHAFFNER	MODULA6150	34572	2018-03-16	2019-03-15
10	Fast Transient Noise Simulator	Noiseken	FNS-105AX	31485	2018-03-16	2019-03-15
11	Color TV Pattern Genenerator	PHILIPS	PM5418	TM209947	N/A	N/A
12	Power Frequency Magnetic Field Generator	EVERFINE	EMS61000-8K	608002	2018-03-16	2019-03-15
13	Capacitive Coupling Clamp	TESEQ	CDN8014	25096	2018-03-16	2019-03-15
14	High Field Biconical Antenna	ELECTRO-METRICS	EM-6913	166	2018-03-16	2019-03-15
15	Log Periodic Antenna	ELECTRO-METRICS	EM-6950	811	2018-03-16	2019-03-15
16	Remote Active Vertical Antenna	ELECTRO-METRICS	EM-6892	304	2018-03-16	2019-03-15
17	TRILOG Broadband Test-Antenna	SCHWARZ BECK	VULB9163	9163-324	2018-03-16	2019-03-15
18	Horn Antenna	SCHWARZ BECK	BBHA9120A	B08000991-0001	2018-03-16	2019-03-15
19	Teo Line Single Phase Module	SCHWARZ BECK	NSLK8128	D-69250	2018-03-16	2019-03-15
20	Electricity bridge	Zentech	100 LCR METER	803024	2018-03-16	2019-03-15
21	RF Current Probe	FCC	F-33-4	80	N/A	N/A
22	Signal Generator	HP	8647A	3349A02296	2018-03-16	2019-03-15
23	Projection Speaker rowave Amplifier	HP	8349B	2627A00994	2018-03-16	2019-03-15
24	Triple-Loop Antenna	EVERFINE	LLA-2	607004	2018-03-16	2019-03-15



2 - SYSTEM TEST CONFIGURATION

2.1 Justification

The system was configured for testing in a typical fashion (as normally used by a typical user).

2.2 EUT Exercise Software

The EUT exercising program used during radiated and conducted testing was designed to exercise the various system components in a manner similar to a typical use. The software offered by manufacturer, can let the EUT being normal operation.

2.3 Special Accessories

As shown in section 2.5, interface cable used for compliance testing is shielded as normally supplied by manufacturer and its respective support equipment manufacturers.

2.4 Basic Configuration of Test System

Emission: The equipment under test (EUT) was configured to measure its highest possible radiation level. The test modes were adapted accordingly in reference to the Operating Instructions.

Immunity: The equipment under test (EUT) was configured to the representative operating mode and conditions.

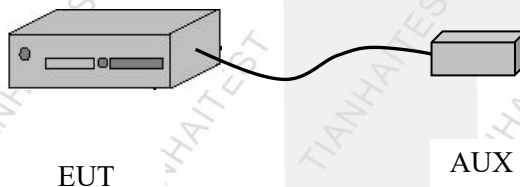

2.5 Test Setup Diagram

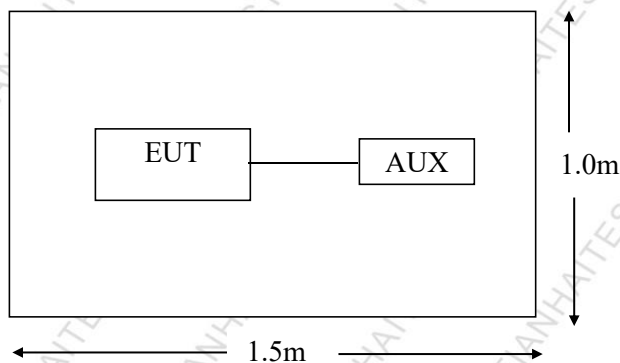



3 - DISTURBANCE VOLTAGE AT THE MAINS TERMINALS

3.1 Measurement Uncertainty

All measurements involve certain levels of uncertainties, especially in field of EMC. The factors contributing to uncertainties are spectrum analyzer, cable loss, and LISN.

The Treatment of Uncertainty in EMC Measurements, the best estimate of the uncertainty of any conducted emissions measurement is 3.4 dB.

3.2 Limit of Disturbance Voltage At The Mains Terminals (Class B)

Frequency Range (MHz)	Limits (dBuV)	
	Quasi-Peak	Average
0.150~0.500	66~56	56~46
0.500~5.000	56	46
5.000~30.00	60	50

Note: (1)The tighter limit shall apply at the edge between two frequency bands.

3.3 EUT Setup

The setup of EUT is according with CISPR 32 measurement procedure. The specification used was the EN 55032 limits.

The EUT was placed center and the back edge of the test table.

The AV cables were draped along the test table and bundled to 30-40cm in the middle.

The spacing between the peripherals was 10 cm.

Maximum emission emitted from EUT was determined by manipulating the EUT, support equipment, interconnecting cables and varying the mode of operation and the levels in the final result of the test were recorded with the EUT running in the operating mode that maximum emission was emitted.

3.4 Instrument Setup

The test receiver was set with the following configurations:

Test Receiver Setting:

Frequency Range.....150 KHz to 30 MHz
 Detector.....Peak & Quasi-Peak & Average
 Sweep Speed.....Auto
 IF Band Width.....9 KHz



3.5 Test Procedure

During the conducted emission test, the EUT power cord was connected to the auxiliary outlet of the first Artificial Mains.

Maximizing procedure was performed on the six (6) highest emissions to ensure EUT compliance using all installation combination.

All data was recorded in the peak detection mode. Quasi-peak and Average readings were only performed when an emission was found to be marginal (within $-10 \text{ dB}_{\mu\text{V}}$ of specification limits). Quasi-peak readings are distinguished with a "QP". Average readings are distinguished with a "AV".

3.6 Summary of Test Results

According to the data in section 3.6, the EUT complied with the EN 55032 Conducted margin, which represented the worst margin reading.

3.7 Disturbance Voltage Test Data

Temperature (°C)	15~35
Humidity (%RH)	30~60
Barometric Pressure (mbar)	860~1060
EUT	Projection Speaker
M/N	T-770
Operating Mode	ON

Test data see following pages

3.8 Test Result

PASS



Disturbance Voltage Test Data

EUT: Projection Speaker M/N: T-770
 Operating Condition: ON
 Test Site: Shielded Room
 Operator: Eric
 Comment: Live Line Tem:24°C Hum:60%

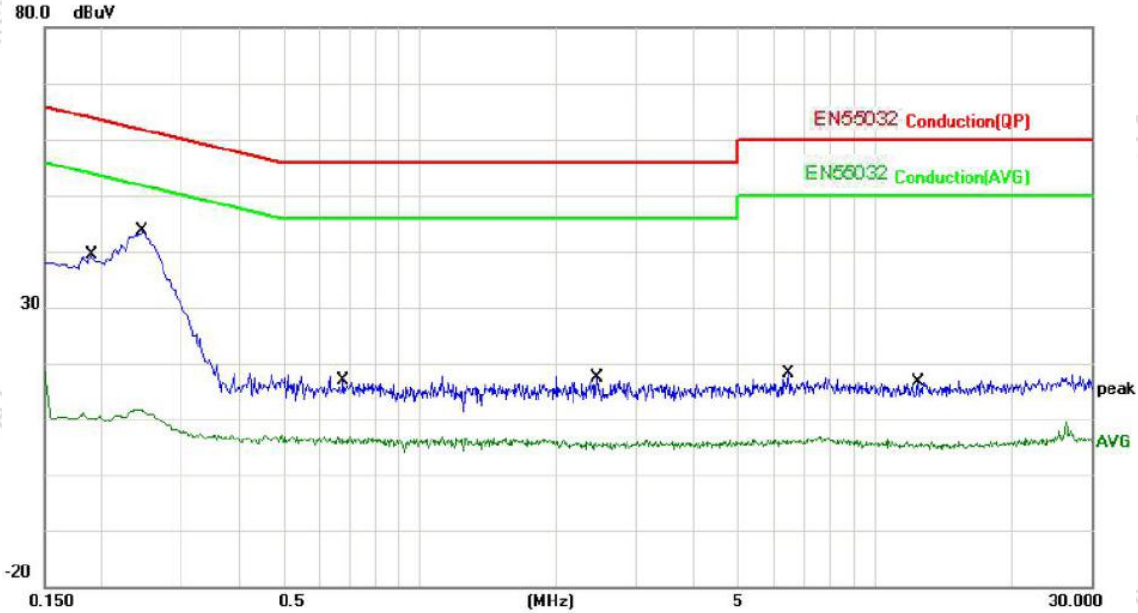

No.	Frequency (MHz)	Factor (dB)	Reading (dBuV)	Level (dBuV)	Limit (dBuV)	Margin (dB)	Detector
1	0.1900	9.78	20.35	30.13	64.04	-33.91	QP
2	0.1900	9.78	-0.25	9.53	54.04	-44.51	AVG
3	0.2460	9.78	26.16	35.94	61.89	-25.95	QP
4	0.2460	9.78	1.36	11.14	51.89	-40.75	AVG
5	0.6820	9.84	-0.69	9.15	56.00	-46.85	QP
6	0.6820	9.84	-3.88	5.96	46.00	-40.04	AVG
7	2.4500	9.88	-0.20	9.68	56.00	-46.32	QP
8	2.4500	9.88	-4.98	4.90	46.00	-41.10	AVG
9	6.4700	9.90	0.03	9.93	60.00	-50.07	QP
10	6.4700	9.90	-4.73	5.17	50.00	-44.83	AVG
11	12.4580	9.91	-0.95	8.96	60.00	-51.04	QP
12	12.4580	9.91	-5.43	4.48	50.00	-45.52	AVG



Disturbance Voltage Test Data

EUT: Projection Speaker M/N: T-770
 Operating Condition: ON
 Test Site: Shielded Room
 Operator: Eric
 Comment: Neutral Line Tem:24℃ Hum:60%

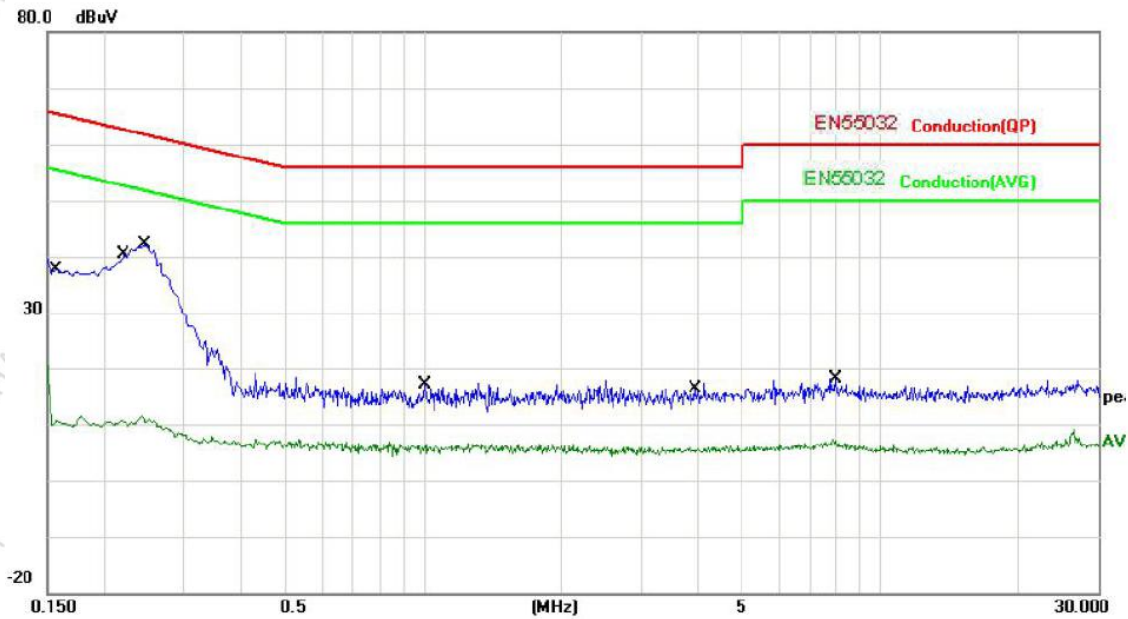

No.	Frequency (MHz)	Factor (dB)	Reading (dBuV)	Level (dBuV)	Limit (dBuV)	Margin (dB)	Detector
1	0.1580	9.78	20.20	29.98	65.57	-35.59	QP
2	0.1580	9.78	-0.06	9.72	55.57	-45.85	AVG
3	0.2220	9.78	23.55	33.33	62.74	-29.41	QP
4	0.2220	9.78	0.46	10.24	52.74	-42.50	AVG
5	0.2460	9.78	25.79	35.57	61.89	-26.32	QP
6	0.2460	9.78	1.22	11.00	51.89	-40.89	AVG
7	1.0060	9.83	-1.09	8.74	56.00	-47.26	QP
8	1.0060	9.83	-4.23	5.60	46.00	-40.40	AVG
9	3.9260	9.90	-0.43	9.47	56.00	-46.53	QP
10	3.9260	9.90	-5.09	4.81	46.00	-41.19	AVG
11	8.0020	9.88	0.35	10.23	60.00	-49.77	QP
12	8.0020	9.88	-4.42	5.46	50.00	-44.54	AVG



4 - DISTURBANCE POWER

4.1 Limit of Disturbance Power

Frequency Range (MHz)	Limit (dBpW)	
	Quasi-Peak	Average
30~300	45~55	35~45

Note: (1) The limit line is a linear line.

4.2 EUT Setup

The setup of EUT is according with CISPR 32 measurement procedure. See following test setup figure. The specification used was the EN 55032 limits.

The EUT was placed at the edge of the test table so as to make the end of the lead close to the EUT as short as possible between the power clamp and the EUT.

The spacing between the peripherals was 10 cm.

Maximum emission emitted from EUT was determined by manipulating the EUT, support equipment, interconnecting cables and varying the mode of operation and the levels in the final result of the test were recorded with the EUT running in the operating mode that maximum emission was emitted.

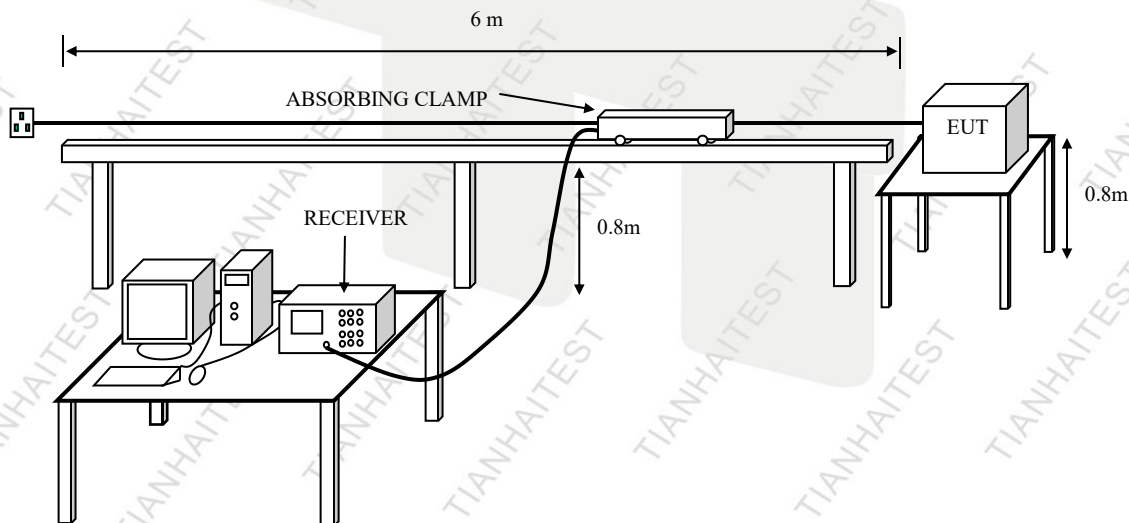



4.3 Instruments Setup

The test receiver was set with the following configurations:

Test Receiver Setting:

Frequency Range.....30 MHz to 300 MHz
 Detector.....Peak & Quasi-Peak & Average
 Sweep Speed.....Auto
 IF Band Width.....9 KHz

4.4 Test Procedure

The associated equipment under test is placed on a non-metallic table of 0.8 m of height above the floor and at least 0.4 m from other objects and from any person. The lead to be measured shall be stretched in a straight horizontal line for a length sufficient to accommodate the absorbing clamp and to permit the necessary adjustment of its position for tuning. The absorbing clamp is placed around the lead to be measured, with its current transformer towards the equipment under test, so as to measure a quantity proportional to the disturbance power on the lead.

Any other lead less than that to be measured shall either be disconnected, if mechanically and functionally possible, or fitted with ferrite rings to attenuate RF currents which may affect the measurement results. Such a lead shall be stretched away from the connected unit in a direction perpendicular to the direction of the lead to be measured.

All connectors not used shall be left un-terminated. All connectors having a connected lead shall be terminated in a manner representative of use. If the leads are screened and normally terminated in a screened unit, then the termination shall be screened.

4.5 Disturbance Power Test Data

Temperature (°C)	15~35
Humidity (%RH)	30~60
Barometric Pressure (mbar)	860~1060
EUT	Projection Speaker
M/N	T-770
Operating Mode	ON

4.6 Test Plot(s) for Disturbance Power

Plot(s) of Conducted Emissions Test Data is presented hereinafter as reference.

4.7 Test Result

PASS



Disturbance Power Test Data

EUT: Projection Speaker M/N: T-770
Operating Condition: ON
Operator: Eric
Comment: AC Line Tem:24°C Hum:60%

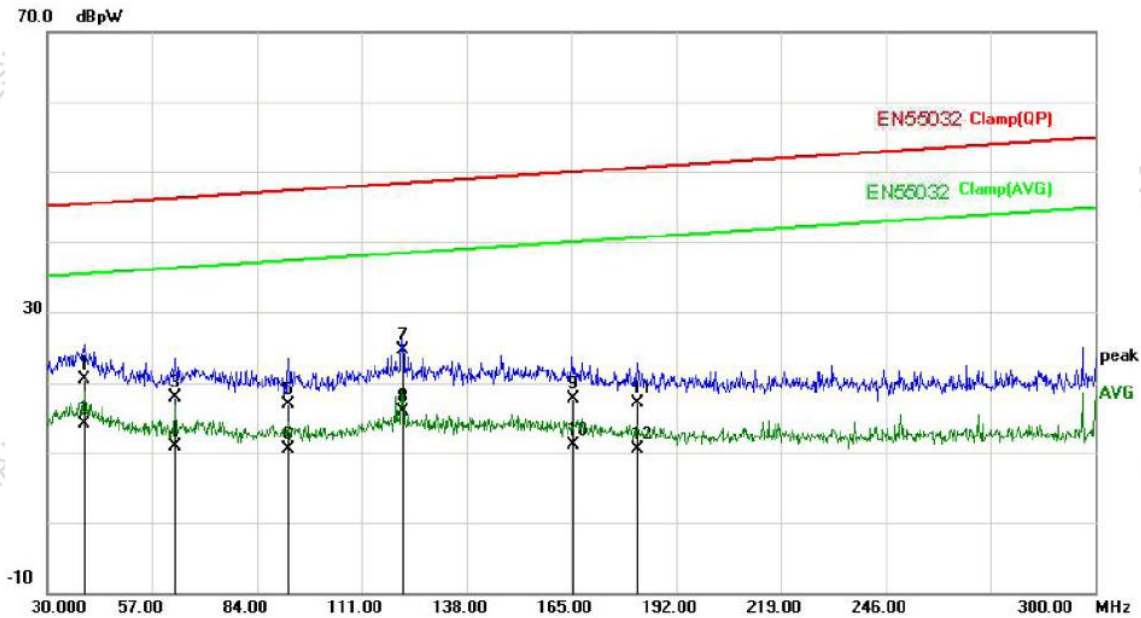

Table with 8 columns: No., Frequency (MHz), Factor (dB), Reading (dBuV), Level (dBuV), Limit (dBuV), Margin (dB), Detector. Contains 12 rows of test data points.



5 - HARMONIC CURRENT TEST (EN 61000-3-2)

5.1 Application of Harmonic Current Emission

Compliance to these standards ensures that tested equipment will not generate harmonic currents at levels that cause unacceptable degradation of the main environment. This directly contributes to meeting compatibility levels established in other EMC standards, which defines compatibility levels for low-frequency conducted disturbances in low-voltage supply systems.

5.2 Measurement Data

Note: For detailed test data, refer to the following pages:

Standard used:	EN/IEC 61000-3-2 A14 (2006) Quasi-stationary - Equipment class A
Observation time:	150s
E. U. T	Projection Speaker
M/N	T-770
Operation Mode	N/A

5.3 Test Results

This EUT is deemed to comply with the requirements of EN 61000-3-2: 2014 without test since the power of EUT is less than 75W.



6 - VOLTAGE FLUCTUATIONS AND FLICKER TEST (EN 61000-3-3)

6.1 Application of Voltage Fluctuations and Flicker Test

Compliance to these standards ensures that tested equipment will not generate flickers and voltage change at levels that cause unacceptable degradation of the main environment. This directly contributes to meeting compatibility levels established in other EMC standards, which defines compatibility levels for low-frequency conducted disturbances in low-voltage supply systems.

6.2 Measurement Data

Note: For detailed test data, refer to the following pages:

Standard used:	EN/IEC 61000-3-3 Flicker
Short time (Pst):	10 min
Observation time:	10 min (1 Flicker measurement)
Flickermeter:	230V/50Hz
E. U. T.:	Projection Speaker
M/N	T-770
Operation Mode	ON

Test Result : PASS

Maximum Flicker results

	EUT values	Limit	Result
Pst	0.041	1.00	PASS
dc [%]	0.028	3.30	PASS
dmax [%]	0.030	4.00	PASS
dt [s]	0.000	0.50	PASS

6.3 Test Results

The EUT was subjected to the voltage fluctuations and flicker test required by EN 61000-3-3: 2013.



7 - EN 55020 TEST PROCEDURES

7.1 Electrostatic Discharge Test System

An EM TEST DITOC0103Z ESD simulator is used for all testing. It is capable of applying Electrostatic discharges in both contact discharge modes to 4 kV and air discharge modes to 8 kV in both positive and negative polarities. This is in accordance with the IEC 61000-4-2 basic EMC publication.

7.2 Radiated Susceptibility Test System

An IFR 2032 signal generator and a Amplifier Research Projection Speaker are used to provide a signal at the appropriate power and frequency to a transmitting antenna to obtain the required electromagnetic field at the position of the EUT in accordance with the IEC 61000-4-3 basic EMC publication. The field was monitored by Amplifier Research field probe and Amplifier Research PM2002 power meter according the IEC 61000-4-3 standards. In order to judge the performance of the EUT, a set of monitor system is used.

7.3 Electrical Fast Transient/Burst Immunity Test System

An EM Test UCS 500-M6 Immunity test system is used for all testing. It is capable of applying fast transients to the AC line at any phase angle with respect to the AC line voltage wave form and to attached cables via a capacitive coupling clamp in accordance with the IEC 61000-4-4 basic EMC publication.

7.4 Surge Immunity Test System

An EM Test UCS 500-M6 Immunity test system is used for all testing. Both positive and negative polarities of voltage up to 2kV were applied to the AC input lines. The coupling network defined in the standard was used.

7.5 Conducted Susceptibility Test System

An IFR 2032A signal generator and a set of Amplifier Research test system are used for the testing. EUT was tested from 0.15 MHz to 80 MHz with 1kHz sine wave, 80% modulation with 3Vr.m.s. CDN coupling and de-coupling networks and EM clamp was tested. During the tests, injected was applied to power line by using CDNs-6.2.2 method, and I/O lines was injected by using EM clamp injection-6.2.3.method.

7.6 Power Frequency Magnetic Field Immunity Test System

An EM Test UCS 500-M6 Immunity test system is used for all testing. Test level as described in IEC 61000-4-8 titled "Table 1 – Test Levels for continuous field" was chosen. Single turn induction coil in 1m x 1m size was used to generate the magnetic field.

7.7 Voltage Dips, Short Interruptions Immunity Tests System

An EM Test UCS 500-M6 Immunity test system is used for all testing. Test level as described in IEC 61000-4-11, section 5, titled "Test Levels".



7.8 Equipment Test Table

IEC 61000-4-2: 1995 specifies that a tabletop EUT shall be placed on a non-conducting table which is 80 centimeters above a ground reference plane and that floor mounted equipment shall be placed on a insulating support approximately 10 centimeters above a ground plane. During the tests, the EUT is positioned over a ground reference plane in conformance with this requirement.

For tabletop equipment, a 1.6 by 0.8-meter metal sheet (HCP) is placed on the table and connected to the ground plane via a metal strap with two 470 k Ohms resistors in series. The EUT and attached cables are isolated from this metal sheet by 0.5-millimeter thick insulating material. A Vertical Coupling Plane (VCP) grounded on the ground plane through the same configuration as in the HCP is used.

IEC 61000-4-3 and IEC 61000-4-4 specify that a tabletop EUT be placed on a non-conducting table 80 centimeters above a ground reference plane and that floor-mounted equipment shall be placed on an insulating support approximately 10 centimeters above a ground plane. During the IEC 61000-4-3 tests, the EUT is positioned on a table in a shielded semi-anechoic test chamber to reduce reflections from the internal surfaces of the chamber. During the IEC 61000-4-4 tests, the EUT is positioned on a table over a ground reference plane in conformance with this requirement.

7.9 Instrument Calibration

All test equipment is regularly checked to ensure that performance is maintained in accordance with the manufacturer's specifications.

Extensive engineering efforts have been made to ensure test data reliability through Quality Control and regular equipment calibration schedules. However, the application of radio frequency fields and voltages are not without an unavoidable level of uncertainty. These include inaccuracies in antenna factors, chamber imperfections and possible test generator output uncertainties.



8 - EN 55020 TEST PROCEDURES

8.1 EUT and Cable Placement

The EUT and any peripherals are located at the center of the table for tabletop devices and in the center of the ground plane with the insulating support for floor-standing devices. The standards require that interconnecting cables to be connected to available ports of the unit and that the placement of the unit and the attached cables simulate a typical installation so far as to be practical.

8.2 Application of Electrostatic Discharge Immunity Test

The test is conducted in the following order according to the basic standard IEC 61000-4-2: Air Discharge, Direct Contact Discharge, Indirect Contact Horizontal Coupling Plane Discharge, and Indirect Contact Vertical Coupling Plane Discharge. The Electrostatic Discharge test levels are set and discharges for the different test modes are set appropriately. The Electrostatic Discharge is applied to the conductive surface of the computer in which the EUT is enclosed, and along all seams and control surfaces on the computer. When a discharge occurs and an error is caused, the type of error, discharge level and location is recorded.

8.3 Application of Radiated Susceptibility Test

The electromagnetic field is established at the front edge of the EUT. The frequency range is swept from 80 to 1000 MHz using a power level necessary to obtain a 3 volt/meter and 80% amplitude of a 1 kHz sine wave modulated field Strength is directed at the EUT. The test is performed with each of four sides of EUT facing the transmitting antenna. If an error is detected when the susceptible side of the EUT facing the transmitting antenna, the field is reduced until the error is not repeatable, the field is then manually increased until the error begins to occur. This threshold level, the frequency and the error created are noted before continuing. Both horizontal and vertical polarization of the antenna are set on test and measured individually

8.4 Application of Electrical Fast Transient/Burst Immunity Test

The EUT was arranged for Power Line Coupling and for I/O Line Coupling through a capacitive clamp, where applicable. (Note: The I/O coupling test using a capacitive clamp is performed on the I/O interface cables that are longer in length than 3 meters.) A metal ground plane 2.4 meter by 2.0 meter was placed between the floor and the table and is connected to the earth by a 2.0 meter ground rod. The ground rod is connected to the test facility's electrical earth.

8.5 Application of Surge Immunity Test

The EUT was setup as described in IEC 61000-4-5 and the test shall be performed according to the test plan.

8.6 Application of Conducted Susceptibility Test

The EUT was setup according to the IEC 61000-4-6 and the test shall be performed with the test generator connected to each of the coupling and decoupling devices in turn while the other non-excited RF input ports of the coupling devices are terminated by a 50 Ω load resistor. The frequency range is 150kHz to 80 MHz.



8.7 Application of Power Frequency Magnetic Field Immunity Test

It is deemed that according to the standard of EN55032, this test is not applicable to the EUT which dose not contain devices susceptible to magnetic fields, such as CRT monitors, Hall elements, electro-dynaProjection Speaker Projection Speaker rophone, magnetic field sensor, etc.

8.8 Application of Voltage Dips, Short Interruptions Immunity Tests

The EUT was setup according to the IEC 61000-4-11 and the test shall be done as the procedure described in the standard.

8.9 Deviations from the Standard

No deviations from EN 55020 were made when performing the tests described in this report.



9 - TEST DATA

9.1 Electrostatic Discharge Immunity Test (IEC 61000-4-2)

Temperature (°C)	15~35
Humidity (%RH)	30~60
Barometric Pressure (mbar)	860~1060
EUT	Projection Speaker
M/N	T-770
Operating Mode	ON

Table 1: Electrostatic Discharge Immunity (Air Discharge)

IEC 61000-4-2 Test Points	Test Levels									
	-2 kV	+2 kV	-4 kV	+4 kV	-6 kV	+6 kV	-8 kV	+8 kV	-15 kV	+15 kV
Slot	A	A	A	A	A	A	A	A	/	/

Table 2: Electrostatic Discharge Immunity (Direct Contact)

IEC 61000-4-2 Test Points	Test Levels									
	-2 kV	+2 kV	-4 kV	+4 kV	-6 kV	+6 kV	-8 kV	+8 kV	-15 kV	+15 kV
Screws	A	A	A	A	/	/	/	/	/	/

Table 3: Electrostatic Discharge Immunity (Indirect Contact HCP)

IEC 61000-4-2 Test Points	Test Levels									
	-2 kV	+2 kV	-4 kV	+4 kV	-6 kV	+6 kV	-8 kV	+8 kV	-15 kV	+15 kV
HCP	A	A	A	A	/	/	/	/	/	/

Table 4: Electrostatic Discharge Immunity (Indirect Contact VCP)

IEC 61000-4-2 Test Points	Test Levels									
	-2 kV	+2 kV	-4 kV	+4 kV	-6 kV	+6 kV	-8 kV	+8 kV	-15 kV	+15 kV
Front Side	A	A	A	A	/	/	/	/	/	/
Back Side	A	A	A	A	/	/	/	/	/	/
Left Side	A	A	A	A	/	/	/	/	/	/
Right Side	A	A	A	A	/	/	/	/	/	/



9.2 Radiated Susceptibility Test (IEC 61000-4-3)

Frequency Range (MHz): 80~1000MHz
Modulation: Amplitude 80%, 1kHz sinewave
Severity Level: 3V/m

Temperature (°C)	15~35
Humidity (%RH)	30~60
Barometric Pressure (mbar)	860~1060
EUT	Projection Speaker
M/N	T-770
Operating Mode	ON

Frequency Range (MHz)	Front (3 V/m)		Rear (3 V/m)		Left Side (3 V/m)		Right Side (3 V/m)	
	VERT	HORI	VERT	HORI	VERT	HORI	VERT	HORI
80-1000 1400-2700	A	A	A	A	A	A	A	A

9.3 Electrical Fast Transient/Burst Immunity Test (IEC 61000-4-4)

Temperature (°C)	15~35
Humidity (%RH)	30~60
Barometric Pressure (mbar)	860~1060
EUT	Projection Speaker
M/N	T-770
Operating Mode	ON

IEC 61000-4-4 Test Points		Test Levels (kV)							
		+0.5	-0.5	+1.0	-1.0	+2.0	-2.0	+4.0	-4.0
Power Supply	L	A	A	A	A	/	/	/	/
	N	A	A	A	A	/	/	/	/
	PE	/	/	/	/	/	/	/	/
Power Line of EUT	L+N	A	A	A	A	/	/	/	/
	L + PE	/	/	/	/	/	/	/	/
	N + PE	/	/	/	/	/	/	/	/
	L +N + PE	/	/	/	/	/	/	/	/



9.4 Surge Immunity Test (IEC 61000-4-5)

Temperature (°C)	15~35
Humidity (%RH)	30~60
Barometric Pressure (mbar)	860~1060
EUT	Projection Speaker
M/N	T-770
Operating Mode	ON

Table 1: Surge Power Supply

Level	Voltage	Poll	Path	Pass	Fail
1	0.5kV	±	L-N	A	/
2	1kV	±	L-N	A	/
3	2kV	±	L-PE, N-PE	/	/
4	4kV	±	L-N, L-PE, N-PE	/	/

9.5 Conducted Susceptibility Test (IEC 61000-4-6)

Frequency Range (MHz): 0.15~80MHz
Modulation: Amplitude 80%, 1kHz sinewave
Severity Level: 3Vr.m.s.

Temperature (°C)	15~35
Humidity (%RH)	30~60
Barometric Pressure (mbar)	860~1060
EUT	Projection Speaker
M/N	T-770
Operating Mode	ON

Level	Voltage Level (e.m.f.) U ₀	Pass	Fail
1	1	/	/
2	3	A	/
3	10	/	/
X	Special	/	/



9.6 Voltage Dips, Short Interruptions Immunity Tests (IEC 61000-4-11)

Temperature (°C)	15~35
Humidity (%RH)	30~60
Barometric Pressure (mbar)	860~1060
EUT	Projection Speaker
M/N	T-770
Operating Mode	ON

Level	U2	td	Phase Angle	N	Pass	Fail
1	>95%	10ms	0/90/180/270	3	B	/
2	30%	500ms	N/A	3	C	/
3	>95%	5000ms	N/A	3	C	/

Note:

- A. The apparatus shall continue to operate as intended during and after the test. The manufacturer specifies some minimum performance level. The performance level may be specified by the manufacturer as a permissible loss of performance.
- B. The apparatus shall continue to operate as intended after the test. This indicates that the EUT does not need to function at normal performance levels during the test, but must recover. Again some minimal performance is defined by the manufacture. No change in operating state or loss or data is permitted.
- C. Temporary loss of function is allowed. Operation of the EUT may stop as long as it is either automatically reset or can be manually restored by operation of the controls.



10 - TEST RESULTS

The following tests were performed on the EUT; the actual test results are contained within the Test Data section of this report.

10.1 IEC 61000-4-2 Electrostatic Discharge Immunity Test Configuration

The EUT was subjected to the electrostatic discharge tests required by EN 55020 and all lower levels specified in IEC 61000-4-2.

The EUT continued to perform as intended during and after the application of the ESD.

10.2 IEC 61000-4-3 Radiated Susceptibility Test Configuration

The EUT was subjected to a 3-volt/meter, 80% Amplitude, 1 kHz Sine wave field as required by EN 55020 and all lower levels specified in IEC 61000-4-3.

The EUT continued to perform as intended during and after the application of the electromagnetic field.

10.3 IEC 61000-4-4 Electrical Fast Transient/Burst Immunity Test Configuration

The EUT was subjected to the electrical fast transient tests required by EN 55020 and all lower levels specified in IEC 61000-4-4.

The EUT continued to perform as intended during and after the application of the EFT/B.

10.4 IEC 61000-4-5 Surge Immunity Test Configuration

The EUT was subjected to the Surge Immunity tests required by EN 55020 and all lower levels specified in IEC 61000-4-5.

The EUT continued to perform as intended during and after the application of the Surge Immunity Test.

10.5 IEC 61000-4-6 Conducted Susceptibility Test Configuration

The EUT was subjected to the Conducted Susceptibility tests required by EN 55020 and all lower levels specified in IEC 61000-4-6.

The EUT continued to perform as intended during and after the application of the Conducted Susceptibility Test.

10.6 IEC 61000-4-11 Voltage Dips, Short Interruptions Immunity Tests Configuration

The EUT was subjected to the Voltage Dips/Interruptions tests required by EN 55020 and all lower levels specified in IEC 61000-4-11.

The EUT continued to perform as intended during and after the application of the Voltage Dips/Interruptions Test.



APPENDIX A - PRODUCT LABELING

CE Marking Label Specification

Specification: Text is Black or white in color and is left justified. Labels are printed in indelible ink on permanent adhesive backing and shall be affixed at a conspicuous location on the EUT or silk-screened onto the EUT.

Proposed Label Location on EUT

EUT Rear View/Proposed CE Marking Location

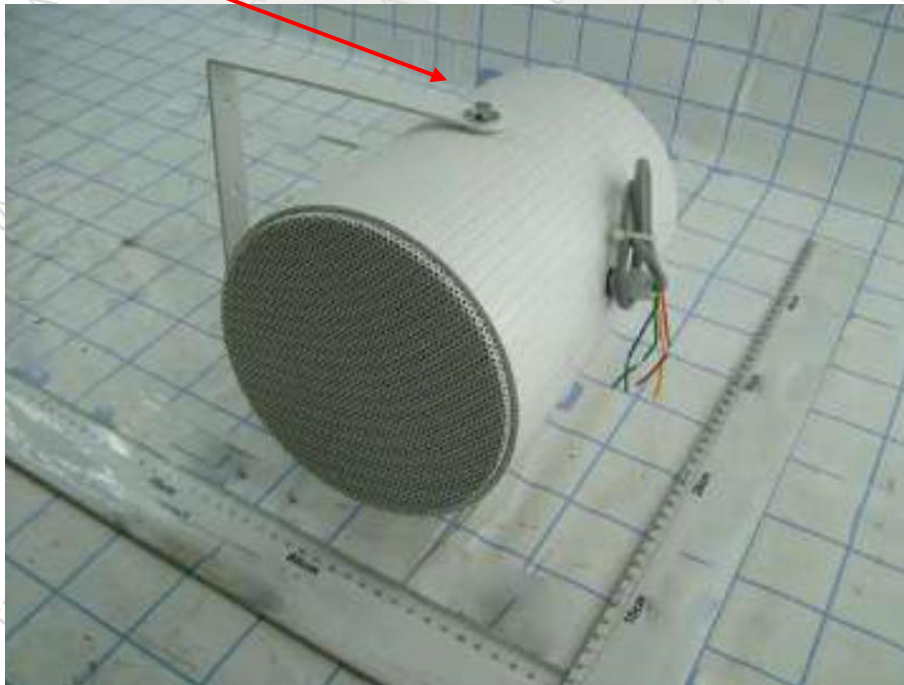



APPENDIX B - EUT PHOTOGRAPHS

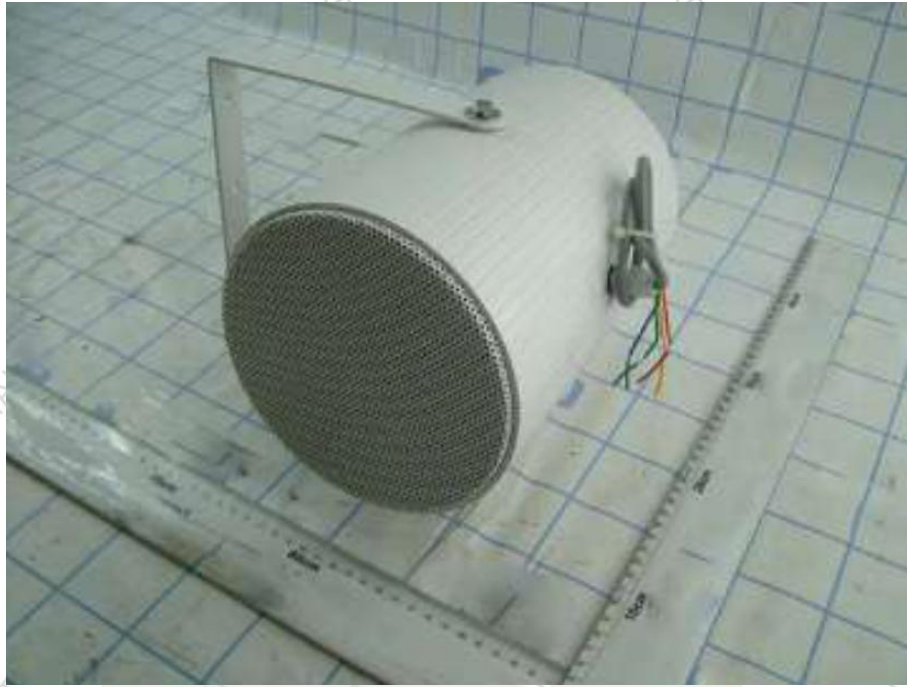





APPENDIX C - TEST SETUP PHOTOGRAPHS



*****END OF THE REPORT*****